

[click here to see hardware and mounting options](#)

# Type 550C 105 °C High Ripple, Inverter Grade, Aluminum

## Ultra-Ripple, Long Life Screw Terminal Type



Type 550C is the standard for motor drive and other high-ripple, long-life applications. It boasts more than 25% extra ripple capability per can size, but less capacitance than Type 520C. Expected operating life is more than 100,000 hours in typical applications. Type 550C is rated for 20,000 h life with full ripple current, rated voltage, 85 °C and 100 lfm airflow while mounted horizontally. Horizontal mounting is more severe than vertical mounting. The extended cathode foil of the 550C assures heat flow from the capacitor element to the can in all orientations.

### Highlights

- Load life up to 20,000 hours at 85 °C
- High ripple current
- ESRs to 7 mΩ

### Specifications

Temperature Range	-40 °C to +105 °C																																																																													
Rated Voltage Range	200 Vdc to 500 Vdc																																																																													
Capacitance Range	680 µF to 35,000 µF																																																																													
Capacitance Tolerance	-10% +50%																																																																													
Leakage Current	≤3 √CV µA, 4 mA max, 5 minutes																																																																													
Ripple Current Multipliers	<table border="1"> <tr> <td colspan="7">Ambient Temperature</td> </tr> <tr> <td><b>45 °C</b></td> <td><b>55 °C</b></td> <td><b>65 °C</b></td> <td><b>75 °C</b></td> <td><b>85 °C</b></td> <td><b>95 °C</b></td> <td><b>105 °C</b></td> </tr> <tr> <td>1.66</td> <td>1.52</td> <td>1.37</td> <td>1.20</td> <td>1.00</td> <td>0.75</td> <td>0.36</td> </tr> </table> <table border="1"> <tr> <td colspan="7">Frequency</td> </tr> <tr> <td><b>50 Hz</b></td> <td><b>60 Hz</b></td> <td><b>120 Hz</b></td> <td><b>360 Hz</b></td> <td><b>1 kHz</b></td> <td><b>5 kHz</b></td> <td><b>10 kHz &amp; up</b></td> </tr> <tr> <td colspan="7"><b>1 3/8" &amp; 2 1/2" Diameters</b></td> </tr> <tr> <td><b>200 to 350 V</b></td> <td>0.77</td> <td>0.82</td> <td>1.00</td> <td>1.21</td> <td>1.32</td> <td>1.37</td> </tr> <tr> <td><b>400 to 500 V</b></td> <td>0.73</td> <td>0.78</td> <td>1.00</td> <td>1.33</td> <td>1.53</td> <td>1.66</td> </tr> <tr> <td colspan="7"><b>3" &amp; 3 1/2" Diameters</b></td> </tr> <tr> <td><b>200 to 350 V</b></td> <td>0.80</td> <td>0.85</td> <td>1.00</td> <td>1.17</td> <td>1.24</td> <td>1.28</td> </tr> <tr> <td><b>400 to 500 V</b></td> <td>0.73</td> <td>0.79</td> <td>1.00</td> <td>1.31</td> <td>1.51</td> <td>1.63</td> </tr> </table>	Ambient Temperature							<b>45 °C</b>	<b>55 °C</b>	<b>65 °C</b>	<b>75 °C</b>	<b>85 °C</b>	<b>95 °C</b>	<b>105 °C</b>	1.66	1.52	1.37	1.20	1.00	0.75	0.36	Frequency							<b>50 Hz</b>	<b>60 Hz</b>	<b>120 Hz</b>	<b>360 Hz</b>	<b>1 kHz</b>	<b>5 kHz</b>	<b>10 kHz &amp; up</b>	<b>1 3/8" &amp; 2 1/2" Diameters</b>							<b>200 to 350 V</b>	0.77	0.82	1.00	1.21	1.32	1.37	<b>400 to 500 V</b>	0.73	0.78	1.00	1.33	1.53	1.66	<b>3" &amp; 3 1/2" Diameters</b>							<b>200 to 350 V</b>	0.80	0.85	1.00	1.17	1.24	1.28	<b>400 to 500 V</b>	0.73	0.79	1.00	1.31	1.51	1.63
Ambient Temperature																																																																														
<b>45 °C</b>	<b>55 °C</b>	<b>65 °C</b>	<b>75 °C</b>	<b>85 °C</b>	<b>95 °C</b>	<b>105 °C</b>																																																																								
1.66	1.52	1.37	1.20	1.00	0.75	0.36																																																																								
Frequency																																																																														
<b>50 Hz</b>	<b>60 Hz</b>	<b>120 Hz</b>	<b>360 Hz</b>	<b>1 kHz</b>	<b>5 kHz</b>	<b>10 kHz &amp; up</b>																																																																								
<b>1 3/8" &amp; 2 1/2" Diameters</b>																																																																														
<b>200 to 350 V</b>	0.77	0.82	1.00	1.21	1.32	1.37																																																																								
<b>400 to 500 V</b>	0.73	0.78	1.00	1.33	1.53	1.66																																																																								
<b>3" &amp; 3 1/2" Diameters</b>																																																																														
<b>200 to 350 V</b>	0.80	0.85	1.00	1.17	1.24	1.28																																																																								
<b>400 to 500 V</b>	0.73	0.79	1.00	1.31	1.51	1.63																																																																								
Low Temperature Characteristics	Impedance ratio: $Z_{-20°C}/Z_{+25°C}$ ≤ 3 (200–500 Vdc)																																																																													
Endurance Life Test	5,000 hr. load life at 85 °C 10,000 hr. load life at 105 °C Δ Capacitance ±20% ESR 200% of limit DCL 100% of limit																																																																													
Operating Life	<table border="1"> <thead> <tr> <th>Diameter</th> <th>Rated Voltage and Ripple Current @105 °C (hours)</th> <th>Rated Voltage @105 °C (hours)</th> </tr> </thead> <tbody> <tr> <td>2½" (66)</td> <td>15000</td> <td>18000</td> </tr> <tr> <td>3" (77)</td> <td>15000</td> <td>18000</td> </tr> <tr> <td>3½ (90)</td> <td>15000</td> <td>18000</td> </tr> </tbody> </table> Load life up to 20000 hours at 105 °C with 90% VDC	Diameter	Rated Voltage and Ripple Current @105 °C (hours)	Rated Voltage @105 °C (hours)	2½" (66)	15000	18000	3" (77)	15000	18000	3½ (90)	15000	18000																																																																	
Diameter	Rated Voltage and Ripple Current @105 °C (hours)	Rated Voltage @105 °C (hours)																																																																												
2½" (66)	15000	18000																																																																												
3" (77)	15000	18000																																																																												
3½ (90)	15000	18000																																																																												
Shelf Life Test	500 h at 105 °C Capacitance 100% of limit ESR 100% of limit DCL 100% of limit																																																																													
Vibration	10 to 55 Hz, 0.06" and 10 g max, 1.5 h each of two axis																																																																													

RoHS Compliant

# Type 550C 105 °C High Ripple, Inverter Grade, Aluminum

## Ultra-Ripple, Long Life Screw Terminal Type

### Part Numbering System

550C	812	T	450	FG	2	D	S
<b>Type</b>	<b>Capacitance</b>	<b>Tolerance</b>	<b>Voltage</b>	<b>Case Code</b>	<b>Insulation</b>	<b>Terminal</b>	<b>Can Style</b>
	812 = 8100 µF	M = ±20% U = -10%+75% T = -10%+50%	200 = 200 Vdc		0 = None 1 = Polyester 2 = PVC	A = Low Post B = High Post D = High Current, Low Post E = High Current, High Post F = M5 Post M = M5 Post, Small G = M6 Low Post H = M6 High Post	Blank = Standard Can S = Stud Bottom P = Stud with Thermal Pad

Standard insulation is 0.008-in PVC sleeve with 0.01-in polypropylene end disk.  
Polyester insulation is not available for 3.5 inch diameter units.

### Outline Drawing

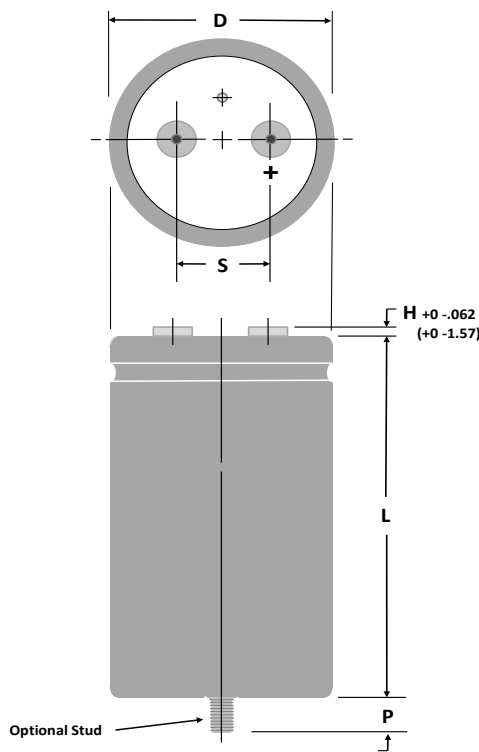

### Stud Dimensions

Case Diam.	Stud Thread	P ± 0.039" (±1.0 mm)
1.375	M8	0.470" (12.0)
1.750	M8	0.470" (12.0)
2.000	M12	0.630" (16.0)
2.500	M12	0.630" (16.0)
3.000	M12	0.630" (16.0)
3.500	M12	0.630" (16.0)

NOTE: With the stud-mount feature, a thermally-conductive disk can be inserted in the bottom flush with the outer insulating sleeve. This reduces the thermal resistance through the can bottom by 0.3 °C/W. Can Style P.

### Terminal Dimensions

Terminal Style	For Case		Post Diameter		H max		Thread	min Full Thread		Torque	
	Diameters	Code	in	mm	in	mm		in	mm	in-lb	N-m
Low Post	1 3/8 to 3	A	0.314	8.0	0.094	2.4	10-32	0.218	5.5	25	2.82
High Post	1 3/8 to 3	B	0.314	8.0	0.281	7.1	10-32	0.375	9.5	25	2.82
High Current, Low	2 1/2 to 3 1/2	D	0.684	17.4	0.125	3.2	1/4-28	0.344	8.7	50	5.65
High Current, High	2 1/2 to 3 1/2	E	0.684	17.4	0.281	7.1	1/4-28	0.469	11.9	60	6.78
M5 Post, Small	1 3/8 to 2	M	0.314	8.0	0.281	7.1	M5	0.375	9.5	25	2.82
M5 Post	2 1/2 & 3	F	0.512	13.0	0.230	5.8	M5	0.344	8.7	25	2.82
M6 Low Post	2 1/2 to 3 1/2	G	0.684	17.4	0.125	3.2	M6	0.344	8.7	50	5.65
M6 High Post	2 1/2 to 3 1/2	H	0.684	17.4	0.281	7.1	M6	0.469	11.9	60	6.78

NOTE: Only high post and M5 post terminals are available at 550 Vdc as they meet the required creepage distance.

# Type 550C 105 °C High Ripple, Inverter Grade, Aluminum

## Ultra-Ripple, Long Life Screw Terminal Type

### Uninsulated Case Dimensions

For insulated case, add 0.024"(0.610 mm) to "D" and 0.030"(0.762 mm) to length.

Case Code	Diam. (D)		Length (L)		Terminals (S)		Typical Weight	
	±.031 Inches	±.78 mm	±.062 Inches	±1.57 mm	±0.015 Inches	±.38 mm	oz	g
AK	1.375	34.93	1.625	41.28	0.50	12.70	1.9	54
AA	1.375	34.93	2.125	53.98	0.50	12.70	2.0	57
AH	1.375	34.93	2.625	66.68	0.50	12.70	2.7	77
AB	1.375	34.93	3.125	79.38	0.50	12.70	3.3	94
AJ	1.375	34.93	3.625	92.08	0.50	12.70	3.8	108
AC	1.375	34.93	4.125	104.78	0.50	12.70	4.4	125
AD	1.375	34.93	4.625	117.48	0.50	12.70	5.1	145
AE	1.375	34.93	5.125	130.18	0.50	12.70	6.8	193
AF	1.375	34.93	5.625	142.88	0.50	12.70	8.1	230
EA	1.750	44.45	2.125	53.98	0.75	19.05	2.7	76
EH	1.750	44.45	2.625	66.68	0.75	19.05	3.8	108
EB	1.750	44.45	3.125	79.38	0.75	19.05	5.1	145
EJ	1.750	44.45	3.625	92.08	0.75	19.05	6.8	193
EC	1.750	44.45	4.125	104.78	0.75	19.05	8.1	230
ED	1.750	44.45	4.625	117.48	0.75	19.05	9.0	255
EE	1.750	44.45	5.125	130.18	0.75	19.05	9.5	269
EF	1.750	44.45	5.625	142.88	0.75	19.05	10.5	298
BA	2.000	50.80	2.125	53.98	0.88	22.23	5.4	153
BH	2.000	50.80	2.625	66.68	0.88	22.23	6.1	173
BB	2.000	50.80	3.125	79.38	0.88	22.23	6.8	193
BJ	2.000	50.80	3.625	92.08	0.88	22.23	8.2	232
BC	2.000	50.80	4.125	104.78	0.88	22.23	9.5	269
BD	2.000	50.80	4.625	117.48	0.88	22.23	10.3	292
BE	2.000	50.80	5.125	130.18	0.88	22.23	10.7	303
BF	2.000	50.80	5.625	142.88	0.88	22.23	13.0	369
CH	2.500	63.50	2.625	66.68	1.13	28.58	9.2	261
CB	2.500	63.50	3.125	79.38	1.13	28.58	10.4	295
CJ	2.500	63.50	3.625	92.08	1.13	28.58	12.7	361
CC	2.500	63.50	4.125	104.78	1.13	28.58	15.0	425
CD	2.500	63.50	4.625	117.48	1.13	28.58	17.2	488
CE	2.500	63.50	5.125	130.18	1.13	28.58	19.3	547
CF	2.500	63.50	5.625	142.88	1.13	28.58	21.4	607
DB	3.000	76.20	3.125	79.38	1.25	31.75	16.7	473
DJ	3.000	76.20	3.625	92.08	1.25	31.75	20.0	567
DC	3.000	76.20	4.125	104.78	1.25	31.75	22.2	629
DD	3.000	76.20	4.625	117.48	1.25	31.75	25.5	723
DE	3.000	76.20	5.125	130.18	1.25	31.75	30.0	850
DF	3.000	76.20	5.625	142.88	1.25	31.75	31.9	904
DM	3.000	76.20	6.625	168.28	1.25	31.75	34.4	933.5
DP	3.000	76.20	5.875	149.23	1.25	31.75	32.8	931
DN	3.000	76.20	7.625	193.68	1.25	31.75	39.5	1119
DG	3.000	76.20	8.625	219.08	1.25	31.75	43.3	1227
FC	3.500	88.90	4.125	104.78	1.25	31.75	30.0	850
FD	3.500	88.90	4.625	117.48	1.25	31.75	34.4	976
FE	3.500	88.90	5.125	130.18	1.25	31.75	40.5	1148
FF	3.500	88.90	5.625	142.88	1.25	31.75	43.1	1221
FP	3.500	88.90	5.875	149.23	1.25	31.75	44.3	1257
FN	3.500	88.90	7.625	193.68	1.25	31.75	53.3	1512
FG	3.500	88.90	8.625	219.08	1.25	31.75	58.5	1658
FM	3.500	88.90	6.625	168.28	1.25	31.75	46.4	1315.4

# Type 550C 105 °C High Ripple, Inverter Grade, Aluminum

## Ultra-Ripple, Long Life Screw Terminal Type

### Ratings

MFD	CATALOG NO.	ESR MAX. Ripple Current Max			CASE SIZE DIA X LENGTH
		@ 25°C	@85°C	@ 105°C	
		120 Hz (mOhms)	120 Hz (A)	120 Hz (A)	
<b>200 VDC (250 VDC SURGE)</b>					
2800	550C282T200CH2B	45.4	10.5	3.8	2 1/2 X 2 5/8
4000	550C402T200CB2B	32.6	13.2	4.7	2 1/2 X 3 1/8
5100	550C512T200CJ2B	25.5	15.6	5.6	2 1/2 X 3 5/8
6200	550C622T200CC2B	20.6	18.1	6.5	2 1/2 X 4 1/8
7300	550C732T200CD2B	17.6	20.3	7.3	2 1/2 X 4 5/8
7300	550C732T200DJ2B	21.2	19.1	6.9	3 X 3 5/8
8500	550C852T200CE2B	15.5	22.5	8.1	2 1/2 X 5 1/8
9000	550C902T200DC2B	17.6	21.9	7.9	3 X 4 1/8
9600	550C962T200CF2B	13.8	24.5	8.8	2 1/2 X 5 5/8
11000	550C113T200DD2B	15.1	24.5	8.8	3 X 4 5/8
12000	550C123T200DE2B	13.3	27.0	9.7	3 X 5 1/8
13000	550C133T200FC2D	18.0	23.8	8.6	3 1/2 X 4 1/8
14000	550C143T200DF2B	11.9	29.4	10.6	3 X 5 5/8
15000	550C153T200DP2D	11.4	30.6	11.0	3 X 5 7/8
16000	550C163T200FD2D	15.3	26.8	9.6	3 1/2 X 4 5/8
18000	550C183T200FE2D	13.6	29.4	10.6	3 1/2 X 5 1/8
20000	550C203T200FF2D	12.2	31.9	11.5	3 1/2 X 5 5/8
21000	550C213T200DN2D	9.5	36.8	13.2	3 X 7 5/8
22000	550C223T200FP2D	11.6	33.2	11.9	3 1/2 X 5 7/8
24000	550C243T200DG2D	8.2	40.4	14.6	3 X 8 5/8
30000	550C303T200FN2D	9.3	40.6	14.6	3 1/2 X 7 5/8
35000	550C353T200FG2D	7.9	44.9	16.2	3 1/2 X 8 5/8
<b>250 VDC (300 VDC SURGE)</b>					
2100	550C212T250CH2B	58.6	9.3	3.3	2 1/2 X 2 5/8
4200	550C422T250DB2B	33.5	14.5	5.2	2 1/2 X 3 1/8
4600	550C462T250CC2B	27.1	15.8	5.7	2 1/2 X 4 1/8
5400	550C542T250CD2B	23.1	17.8	6.4	2 1/2 X 4 5/8
5400	550C542T250DJ2B	25.9	17.3	6.2	3 X 3 5/8
6200	550C622T250CE2B	19.8	19.9	7.2	2 1/2 X 5 1/8
6600	550C662T250DC2B	21.5	19.9	7.1	3 X 4 1/8
7100	550C712T250CF2B	17.6	21.7	7.8	2 1/2 X 5 5/8
7800	550C782T250DD2B	18.3	22.3	8.0	3 X 4 5/8
9000	550C902T250DE2B	16.1	24.6	8.9	3 X 5 1/8
9700	550C973T250FC2D	19.1	23.1	8.3	3 1/2 X 4 1/8
10000	550C103T250DF2B	14.4	26.8	9.6	3 X 5 5/8
11000	550C113T250DP2B	13.2	28.2	10.2	3 X 5 7/8
11000	550C113T250FD2D	16.6	25.8	9.3	3 1/2 X 4 5/8
13000	550C133T250FE2D	14.5	28.4	10.2	3 1/2 X 5 1/8

MFD	CATALOG NO.	ESR MAX. Ripple Current Max			CASE SIZE DIA X LENGTH
		@ 25°C	@85°C	@ 105°C	
		120 Hz (mOhms)	120 Hz (A)	120 Hz (A)	
<b>250 VDC (300 VDS SURGE)</b>					
15000	550C153T250DN2D	10.9	34.4	12.4	3 X 7 5/8
15000	550C153T250FF2D	12.8	31.2	11.2	3 1/2 X 5 5/8
16000	550C163T250FP2D	12.2	32.3	11.6	3 1/2 X 5 7/8
17000	550C173T250DG2D	9.2	38.3	13.8	3 X 8 5/8
22000	550C223T250FN2D	9.9	39.5	14.2	3 1/2 X 7 5/8
25000	550C253T250FG2D	8.4	43.7	15.7	3 1/2 X 8 5/8
<b>300 VDC (350 VDC SURGE)</b>					
1600	550C162T300CH2B	90.7	7.4	2.7	2 1/2 X 2 5/8
2200	550C222T300CB2B	65.1	9.3	3.4	2 1/2 X 3 1/8
2800	550C282T300CJ2B	50.8	11.1	4.0	2 1/2 X 3 5/8
3400	550C342T300DB2B	43.7	12.7	4.6	3 X 3 1/8
3500	550C352T300CC2B	41.6	12.8	4.6	2 1/2 X 4 1/8
4100	550C412T300CD2B	35.5	14.4	5.2	2 1/2 X 4 5/8
4400	550C442T300DJ2B	34.2	15.1	5.4	3 X 3 5/8
4700	550C472T300CE2B	31.0	15.9	5.7	2 1/2 X 5 1/8
5300	550C532T300CF2B	27.1	17.5	6.3	2 1/2 X 5 5/8
5400	550C542T300DC2B	28.3	17.3	6.2	3 X 4 1/8
6400	550C642T300DD2B	24.1	19.4	7.0	3 X 4 5/8
7200	550C722T300FC2D	21.8	21.7	7.8	3 1/2 X 4 1/8
7400	550C742T300DE2B	21.1	21.5	7.7	3 X 5 1/8
8300	550C832T300DF2B	18.8	23.4	8.4	3 X 5 5/8
8600	550C862T300FD2D	18.6	24.3	8.8	3 1/2 X 4 5/8
8800	550C882T300DP2B	17.9	24.3	8.8	3 X 5 7/8
9900	550C993T300FE2D	16.2	26.8	9.7	3 1/2 X 5 1/8
11000	550C113T300FF2D	14.0	29.6	10.7	3 1/2 X 5 5/8
12000	550C123T300FP2D	13.3	30.8	11.1	3 1/2 X 5 7/8
12000	550C123T300DN2B	14.4	30.0	10.8	3 X 7 5/8
14000	550C143T300DG2D	12.2	33.3	12.0	3 X 8 5/8
16000	550C163T300FN2D	10.7	38.1	13.7	3 1/2 X 7 5/8
18000	550C183T300FG2D	8.9	42.3	15.2	3 1/2 X 8 5/8
<b>350 VDC (400 VDC SURGE)</b>					
1300	550C132T350CH2B	100.6	7.1	2.5	2 1/2 X 2 5/8
1800	550C182T350CB2B	72.0	8.8	3.2	2 1/2 X 3 1/8
2300	550C232T350CJ2B	56.3	10.5	3.8	2 1/2 X 3 5/8
2800	550C282T350CC2B	46.4	12.1	4.4	2 1/2 X 4 1/8
2800	550C282T350DB2B	47.8	12.2	4.4	3 X 3 1/8
3300	550C332T350CD2B	39.4	13.6	4.9	2 1/2 X 4 5/8
3600	550C362T350DJ2B	37.4	14.5	5.2	3 X 3 5/8

# Type 550C 105 °C High Ripple, Inverter Grade, Aluminum

## Ultra-Ripple, Long Life Screw Terminal Type

MFD	CATALOG NO.	ESR MAX. Ripple Current Max			CASE SIZE DIA X LENGTH
		@ 25°C	@85°C	@ 105°C	
		120 Hz (mOhms)	120 Hz (A)	120 Hz (A)	
<b>350 VDC (400 VDC SURGE)</b>					
3800	550C382T350CE2B	34.5	15.1	5.4	2 1/2 X 5 1/8
4300	550C432T350CF2B	29.9	16.7	6.0	2 1/2 X 5 5/8
4400	550C442T350DC2B	30.9	16.6	6.0	3 X 4 1/8
5100	550C512T350DD2B	26.3	18.6	6.7	3 X 4 5/8
5800	550C582T350FC2D	23.8	20.8	7.5	3 1/2 X 4 1/8
5900	550C592T350DE2B	23.0	20.6	7.4	3 X 5 1/8
6700	550C672T350DF2B	20.5	22.4	8.1	3 X 5 5/8
6900	550C692T350FD2D	20.3	23.3	8.4	3 1/2 X 4 5/8
7100	550C712T350DP2B	19.5	23.3	8.4	3 X 5 7/8
8000	550C802T350FE2D	17.7	25.7	9.3	3 1/2 X 5 1/8
9000	550C902T350FF2D	15.3	28.4	10.2	3 1/2 X 5 5/8
9500	550C952T350FP2D	14.5	29.6	10.6	3 1/2 X 5 7/8
9600	550C962T350DN2B	15.4	29.0	10.4	3 X 7 5/8
11000	550C113T350DG2D	12.9	32.3	11.6	3 X 8 5/8
13000	550C133T350FN2D	11.5	36.6	13.2	3 1/2 X 7 5/8
15000	550C153T350FG2D	9.6	40.7	14.6	3 1/2 X 8 5/8
<b>400 VDC (450 VDC SURGE)</b>					
990	550C991T400CH2B	110.4	6.7	2.4	2 1/2 X 2 5/8
1400	550C142T400CB2B	79.1	8.4	3.0	2 1/2 X 3 1/8
1800	550C182T400CJ2B	61.7	10.0	3.6	2 1/2 X 3 5/8
2200	550C222T400CC2B	50.8	11.6	4.2	2 1/2 X 4 1/8
2200	550C222T400DB2B	53.0	11.6	4.2	3 X 3 1/8
2600	550C262T400CD2B	43.3	13.0	4.7	2 1/2 X 4 5/8
2800	550C282T400DJ2B	41.4	13.7	4.9	3 X 3 5/8
3000	550C302T400CE2B	37.7	14.4	5.2	2 1/2 X 5 1/8
3400	550C342T400CF2B	33.5	15.8	5.7	2 1/2 X 5 5/8
3400	550C342T400DC2B	34.0	15.8	5.7	3 X 4 1/8
4000	550C402T400DD2B	29.0	17.7	6.4	3 X 4 5/8
4600	550C462T400FC2D	25.8	20.0	7.2	3 1/2 X 4 1/8
4700	550C472T400DE2B	24.8	19.8	7.1	3 X 5 1/8
5300	550C532T400DF2B	22.0	21.6	7.8	3 X 5 5/8
5400	550C542T400FD2D	21.9	22.4	8.1	3 1/2 X 4 5/8
5600	550C562T400DP2B	21.0	22.4	8.1	3 X 5 7/8
6200	550C622T400FE2D	19.1	24.7	8.9	3 1/2 X 5 1/8
7100	550C712T400FF2D	16.0	27.3	9.8	3 1/2 X 5 5/8
7500	550C752T400FP2D	15.7	28.4	10.2	3 1/2 X 5 7/8
7800	550C782T400DN2B	16.9	27.6	9.9	3 X 7 5/8
9000	550C902T400DG2D	14.4	30.6	11.0	3 X 8 5/8
9700	550C972T400FN2D	12.6	34.9	12.6	3 1/2 X 7 5/8
11000	550C113T400FG2D	10.7	38.7	13.9	3 1/2 X 8 5/8
<b>450 VDC (500 VDC SURGE)</b>					
700	550C701T450CH2B	125.3	6.3	2.3	2 1/2 X 2 5/8
980	550C981T450CB2B	89.7	7.9	2.9	2 1/2 X 3 1/8
1300	550C132T450CJ2B	66.5	9.7	3.5	2 1/2 X 3 5/8

MFD	CATALOG NO.	ESR MAX. Ripple Current Max			CASE SIZE DIA X LENGTH
		@ 25°C	@85°C	@ 105°C	
		120 Hz (mOhms)	120 Hz (A)	120 Hz (A)	
<b>450 VDC (500 VDC SURGE)</b>					
1500	550C152T450CC2B	57.5	10.9	3.9	2 1/2 X 4 1/8
1500	550C152T450DB2B	55.0	11.3	4.1	3 X 3 1/8
1800	550C182T450CD2B	49.0	12.2	4.4	2 1/2 X 4 5/8
2000	550C202T450DJ2B	42.9	13.5	4.8	3 X 3 5/8
2100	550C212T450CE2B	40.5	13.9	5.0	2 1/2 X 5 1/8
2400	550C242T450CF2B	35.4	15.3	5.5	2 1/2 X 5 5/8
2400	550C242T450DC2B	35.5	15.5	5.6	3 X 4 1/8
2900	550C292T450DD2B	30.3	17.4	6.3	3 X 4 5/8
3200	550C322T450FC2D	26.6	19.6	7.1	3 1/2 X 4 1/8
3300	550C332T450DE2B	26.3	19.2	6.9	3 X 5 1/8
3700	550C372T450DF2B	23.4	20.9	7.5	3 X 5 5/8
3800	550C382T450FD2D	22.6	22.1	7.9	3 1/2 X 4 5/8
4000	550C402T450DP2B	22.3	21.8	7.8	3 X 5 7/8
4400	550C442T450FE2D	19.7	24.3	8.8	3 1/2 X 5 1/8
5000	550C502T450FF2D	17.5	26.5	9.6	3 1/2 X 5 5/8
5300	550C532T450FP2D	16.6	27.6	9.9	3 1/2 X 5 7/8
5500	550C552T450DN2B	18.0	26.8	9.6	3 X 7 5/8
6400	550C642T450DG2D	15.2	29.8	10.7	3 X 8 5/8
7100	550C712T450FN2D	13.1	34.3	12.3	3 1/2 X 7 5/8
8100	550C813T450FG2D	11.0	38.2	13.7	3 1/2 X 8 5/8
<b>500 VDC (550 VDC SURGE)</b>					
680	550C681T500CH2B	228.5	4.7	1.7	2 1/2 X 2 5/8
680	550C961T500CB2B	163.6	5.9	2.1	2 1/2 X 3 1/8
1200	550C122T500CJ2B	126.4	7.0	2.5	2 1/2 X 3 5/8
1400	550C142T500DB2B	100.0	8.4	3.0	3 X 3 1/8
1500	550C152T500CC2B	98.9	8.3	3.0	2 1/2 X 4 1/8
1800	550C182T500CD2B	84.0	9.3	3.4	2 1/2 X 4 5/8
1900	550C192T500DJ2B	76.6	10.1	3.6	3 X 3 5/8
2000	550C202T500CE2B	77.0	10.1	3.6	2 1/2 X 5 1/8
2300	550C232T500DC2B	62.5	11.6	4.2	3 X 4 1/8
2300	550C232T500CF2B	64.6	11.4	4.1	2 1/2 X 5 5/8
2700	550C272T500DD2B	52.4	13.2	4.7	3 X 4 5/8
3100	550C312T450DE2B	45.1	14.7	5.3	3 X 5 1/8
3200	550C322T500FC2D	45.0	15.1	5.4	3 1/2 X 4 1/8
3500	550C352T500DF2B	40.0	16.1	5.8	3 X 5 5/8
3700	550C372T500DP2B	37.6	16.8	6.0	3 X 5 7/8
3800	550C382T500FD2D	37.5	17.1	6.2	3 1/2 X 4 5/8
4300	550C432T500FE2D	32.9	18.8	6.8	3 1/2 X 5 1/8
4900	550C492T500FF2D	28.2	20.9	7.5	3 1/2 X 5 5/8
5200	550C522T500FP2D	26.7	21.8	7.9	3 1/2 X 5 7/8
5400	550C542T500DN2B	30.3	20.9	7.5	3 X 7 5/8
6000	550C602T500DG2B	22.9	24.2	8.7	3 X 8 5/8
7000	550C702T500FN2D	19.7	27.9	10.1	3 1/2 X 7 5/8
8400	550C843T500FG2D	16.6	31.0	11.2	3 1/2 X 8 5/8

# Type 550C 105 °C High Ripple, Inverter Grade, Aluminum

## Ultra-Ripple, Long Life Screw Terminal Type

### Typical Performance Curves

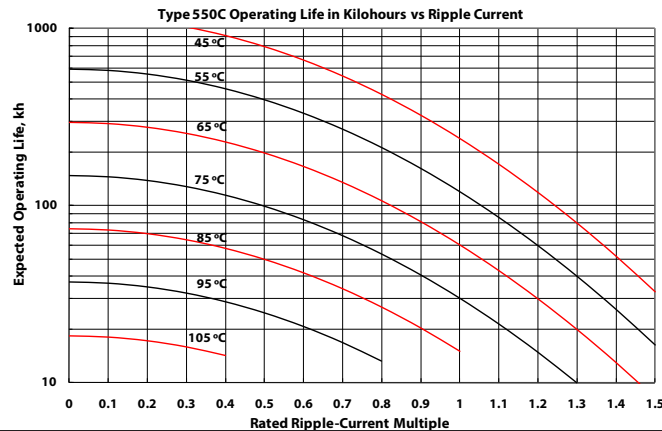
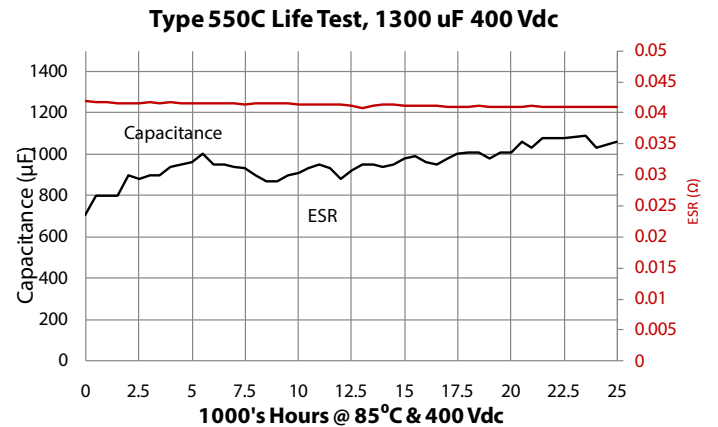
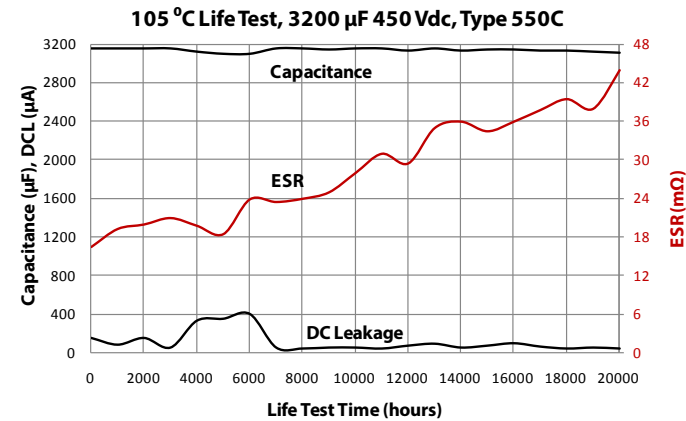
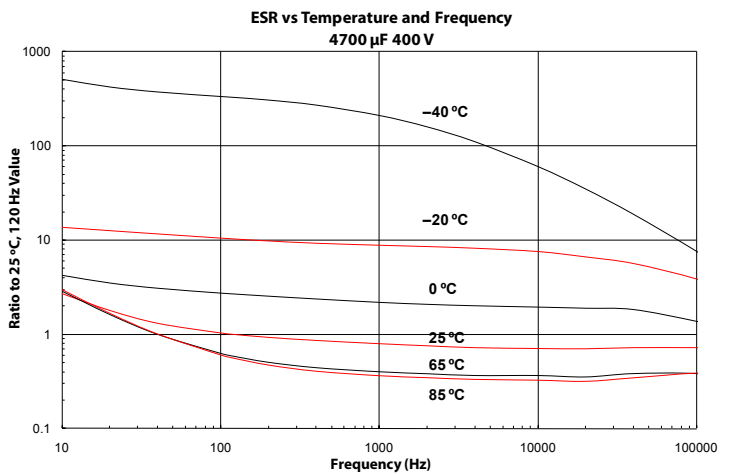
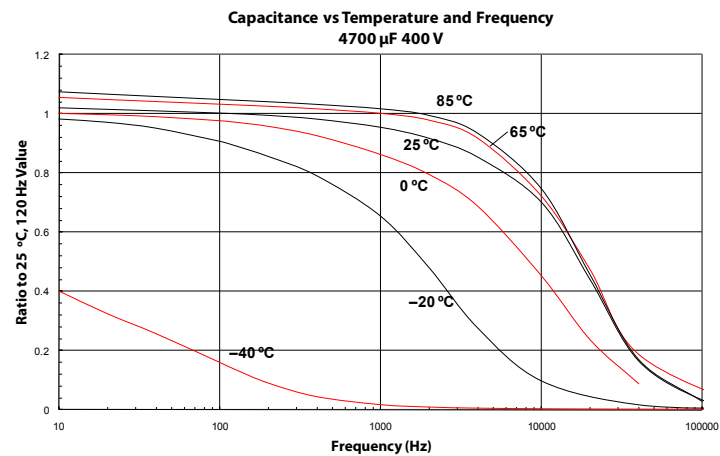
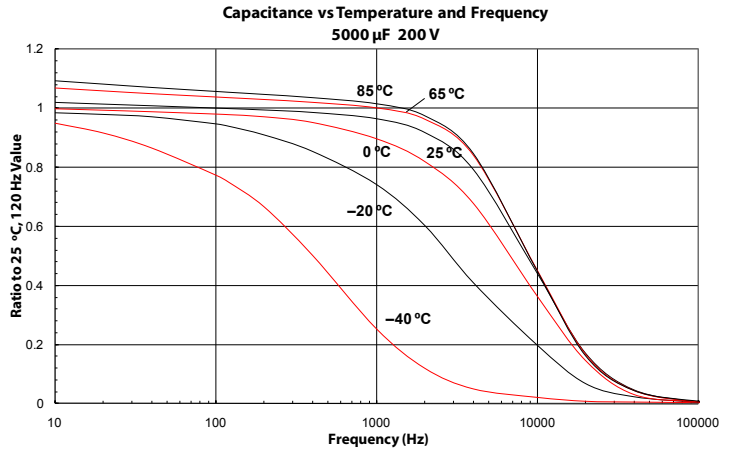
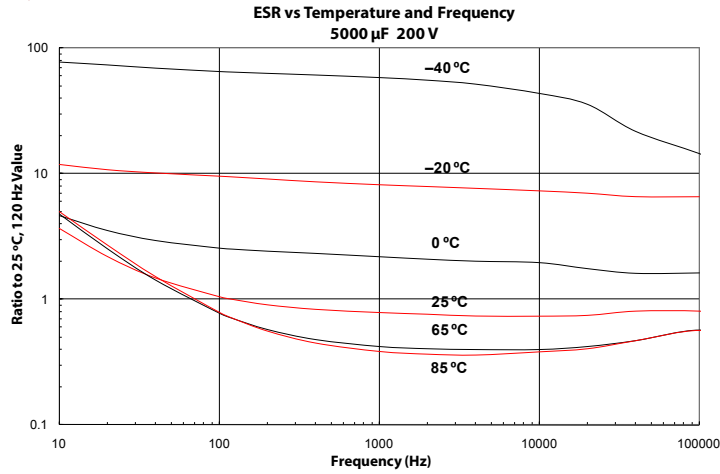

**Notice and Disclaimer:** All product drawings, descriptions, specifications, statements, information and data (collectively, the "Information") in this datasheet or other publication are subject to change. The customer is responsible for checking, confirming and verifying the extent to which the Information contained in this datasheet or other publication is applicable to an order at the time the order is placed. All Information given herein is believed to be accurate and reliable, but it is presented without any guarantee, warranty, representation or responsibility of any kind, expressed or implied. Statements of suitability for certain applications are based on the knowledge that the Cornell Dubilier company providing such statements ("Cornell Dubilier") has of operating conditions that such Cornell Dubilier company regards as typical for such applications, but are not intended to constitute any guarantee, warranty or representation regarding any such matter – and Cornell Dubilier specifically and expressly disclaims any guarantee, warranty or representation concerning the suitability for a specific customer application, use, storage, transportation, or operating environment. The Information is intended for use only by customers who have the requisite experience and capability to determine the correct products for their application. Any technical advice inferred from this Information or otherwise provided by Cornell Dubilier with reference to the use of any Cornell Dubilier products is given gratis (unless otherwise specified by Cornell Dubilier), and Cornell Dubilier assumes no obligation or liability for the advice given or results obtained. Although Cornell Dubilier strives to apply the most stringent quality and safety standards regarding the design and manufacturing of its products, in light of the current state of the art, isolated component failures may still occur. Accordingly, customer applications which require a high degree of reliability or safety should employ suitable designs or other safeguards (such as installation of protective circuitry or redundancies or other appropriate protective measures) in order to ensure that the failure of an electrical component does not result in a risk of personal injury or property damage. Although all product-related warnings, cautions and notes must be observed, the customer should not assume that all safety measures are indicated in such warnings, cautions and notes, or that other safety measures may not be required.

## X-ON Electronics

Largest Supplier of Electrical and Electronic Components

*Click to view similar products for [Aluminum Electrolytic Capacitors - Screw Terminal](#) category:*

*Click to view products by [Cornell Dubilier](#) manufacturer:*

Other Similar products are found below :

[M39018/04-2181M](#) [M39018/06-0125M](#) [M39018/06-0158M](#) [E32D161HPN223MEB7M](#) [E32D161HPN273MED0M](#) [E32D401LPN851TDE3M](#)  
[E32D500HPN333MAB7M](#) [E32D500LPN303TDA5M](#) [E32D630HPN153MA92M](#) [ERWF401LGC472MDF5M](#) [ESME800LGC223MCA0M](#)  
[FAS220250AA](#) [M39018/04-2146M](#) [36DA222F450CC2A](#) [32D502F075CD2B](#) [36D552G040AC2A](#) [36DA103F035AA2A](#)  
[36DA123F100BC2A](#) [36DA223F025BA2A](#) [36DA563F050BF2A](#) [E32D600HPN753UEE3M](#) [E32D750HPN202TA67M](#)  
[E32D800HPC223MD79M](#) [E32D800HPN124MEM9M](#) [36DA152F400BC2AEA](#) [E32D101HLS123MC92M](#) [E32D800HLN682MA79M](#)  
[E74D400LPN302UA54M](#) [E32D501CSS422MFE5M](#) [36DX931F450CC2A](#) [E32D451LPN901TEE3M](#) [ERWF451LGN103MFH0M](#)  
[E32D350HPN224ME92M](#) [ERWF451LGB821MC60M](#) [B43586S0478Q5](#) [36DA683F025BL2A](#) [M39018/06-0139M](#) [E74D400HPN173TCE3M](#)  
[HV101761T250BA2A](#) [ALS36H222L5L350](#) [550322T450DF2BP](#) [550C201T400AA1A](#) [E32D161CPN473MEM9M](#)  
[ERHA601LGC562MFH0U](#) [E32D401MLN181MA41M](#) [E32D401HLN152QDA5M](#) [MAL210213222E3](#) [520C562P400DF2H](#)  
[3186GJ503M125DPA2](#) [3188GN282S400KPA2](#)